

# GRAVIMETRIC BLENDERS

The world's most popular  
blender range with close to  
**60K sold worldwide.**

**10 Blender Series  
Over 120 Models**



**PRODUCT GUIDE**







**60K**

CLOSE TO 60K  
BLENDERS SOLD  
WORLDWIDE



“

Our focus for design,  
in order of importance is:  
performance, serviceability,  
ease of use, and price.

”





# The most popular Gravimetric Blenders Worldwide

The fundamentals of design have always been about accuracy, quick return on investment, and ease of use.

For all our products hardware is constantly evolving that is robust and reliable, plus practically integrated software ensures that products are continuously improved.

Maguire's commitment to these basic design principals and to the feedback from our customers continues to shape and evolve each product.

All Maguire products are guaranteed with an industry leading 5 Year Warranty program.



**1977**  
Intuitive and accurate liquid color pump

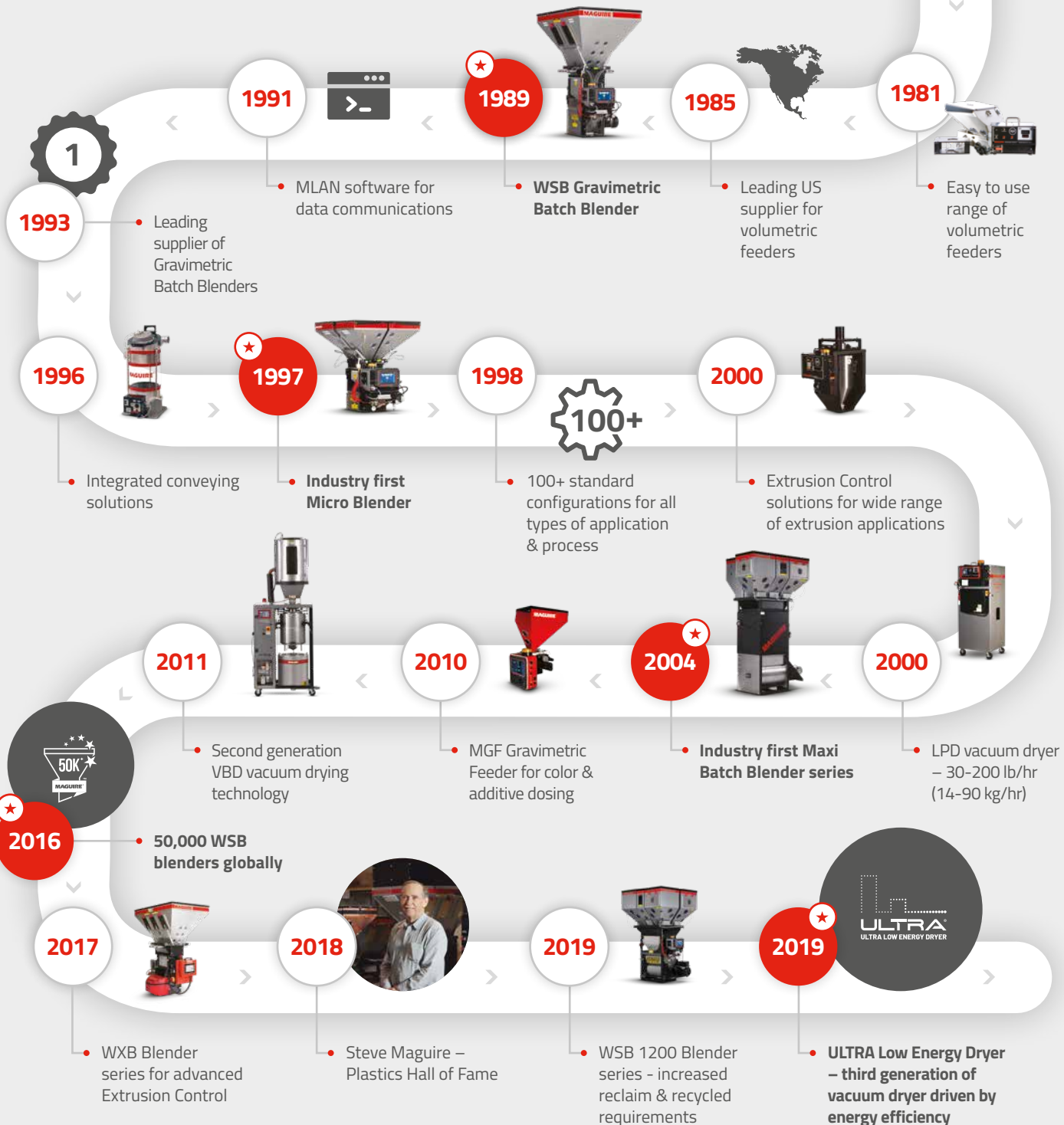

# Do you need a Gravimetric Feeder or a Gravimetric Blender: How to choose?

**Choosing the right equipment could lead to significantly more savings and more production flexibility well into the future.**

Selecting the right materials dosing and mixing control is critical in production efficiency and raw materials cost control.

Maguire Gravimetric Feeders and Gravimetric Batch Blenders eliminate manual handling, and reduce operating costs dramatically.

Choosing between a single component Gravimetric Feeder or a multiple component Gravimetric Blender, should be based on the materials dosing requirements both today and in the future, plus overall process requirements and budget.

**Raw materials account for up to 70% of a processors annual operational cost**

**Return On Investment**

Feeder approx. half the cost of Gravimetric Blender.

Control 2 or more materials with a Gravimetric Blender, versus only up to 2 with a feeder.

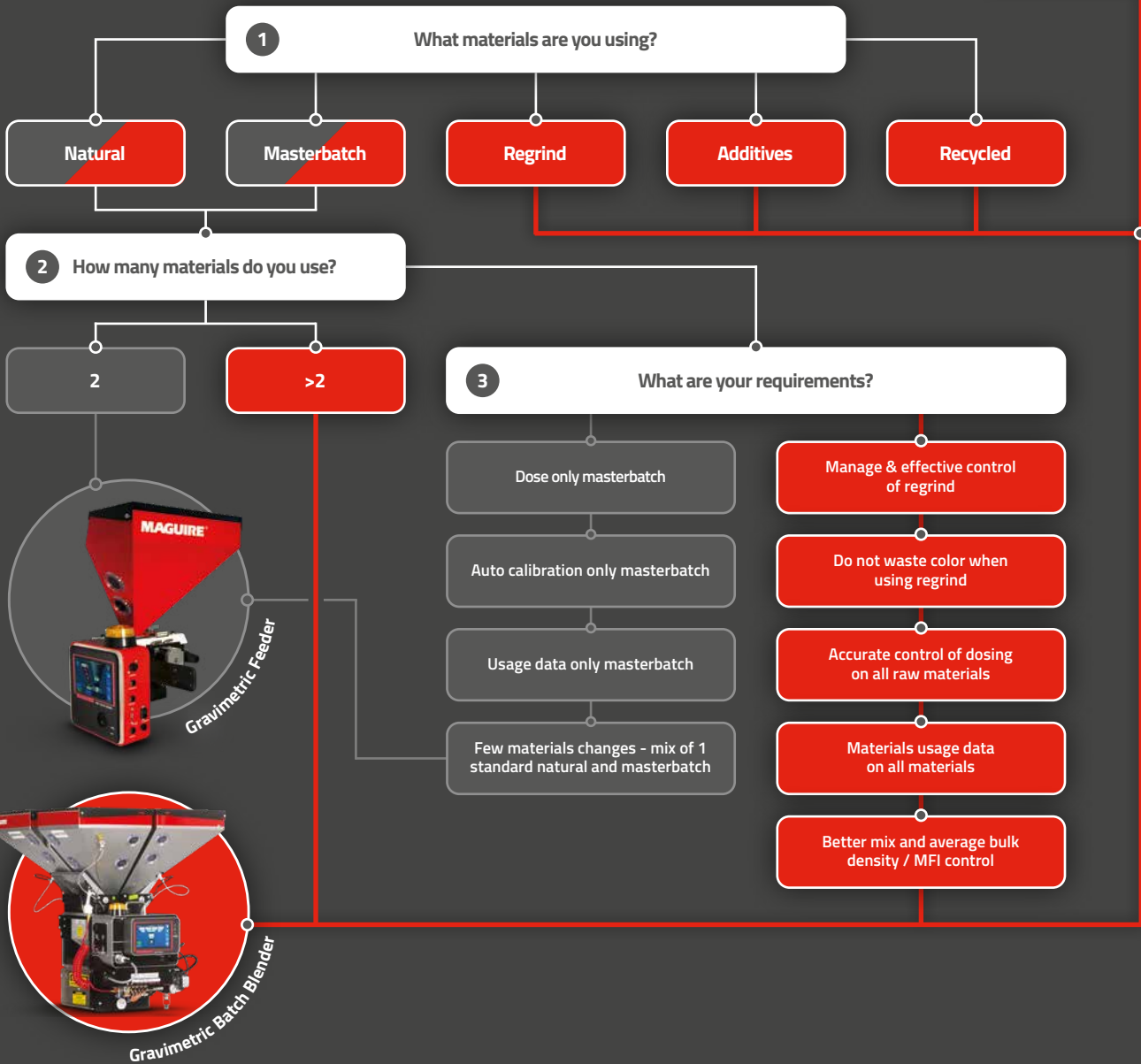



# Why our Blenders?

**A blender should solve ALL your raw material problems. Not just a few!**

01



Our blenders control all materials...  
**Not just one & guess at the rest.**

02



Our blenders are accurate & have been for 3 decades...  
**We set the standard.**

03



Our blenders provide usage data on all materials...  
**Not just one - know your complete process.**

04



Our controls are packed with features & functions as standard...  
**Not optional extras that can't be added later.**

05



Our blenders adjust for regrind usage with every batch...  
**Regrind is recovered at maximum value.**

06



Our controls are fast and simple to use...  
**Not slow or cluttered menu systems.**

07



Our blenders effectively manage vibration...  
**Without compromising installation.**

08



Our blenders are covered by a warranty that's as robust as the blender system itself...  
**It's not just a marketing exercise.**

09



Our blenders provide a sustainable solution for your process...  
**Reduced scrap and waste and increased energy efficiency.**

**"60K installed blenders saves the world over 100 million dollars in reduced material cost and 600 million dollars in improved productivity in plants per year, that is all passed on to the customer."**

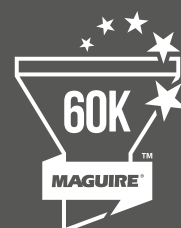

# Blender Range at a Glance

10 blender series with over 120 models suited to every process and application. Maguire offers more models than any other producer, with off the shelf solutions and 30+ years of built in application experience.



1

## MB Series

### Throughput Capacity

Up to: 100 lb/hr | 45 kg/hr

- 5 models available
- Ideal for small injection machines
- Easy flow regrind corner valve
- All hoppers removable for quick cleaning and easy changes
- Up to 4 materials.

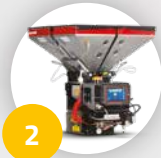

2

## 100MP Series

### Throughput Capacity

Up to: 350 lb/hr | 160 kg/hr

- 5 models available
- For small injection & blow molders, small extrusion lines
- Easy flow regrind corner valve
- All hoppers removable for quick cleaning and easy changes
- Up to 6 materials



3

## 100 Series

### Throughput Capacity

Up to: 450 lb/hr | 200 kg/hr

- 7 models available
- For injection & blow molders, extrusion lines
- High capacity fixed hoppers – 4, 5 or 6 material compartment hoppers
- Removable hoppers for quick color changes
- Up to 6 materials



4

## 200 Series

### Throughput Capacity

Up to: 900 lb/hr | 400 kg/hr

- 12 models available
- For injection & blow molders, extrusion lines, central blending
- High capacity fixed hoppers – 2, 4, 5 or 6 material compartment hoppers
- Removable hoppers for quick color changes
- Up to 8 materials



5

## 400 Series

### Throughput Capacity

Up to: 1450 lb/hr | 650 kg/hr

- 12 models available
- For injection & blow molders, extrusion lines, central blending
- High capacity fixed hoppers – 2, 4, 5 or 6 material compartment hoppers
- Removable hoppers for quick color changes
- Up to 8 materials



6

## 900 Series

### Throughput Capacity

Up to: 3200 lb/hr | 1400 kg/hr

- 21 models available
- For injection & blow molders, extrusion lines, central blending
- High capacity fixed hoppers – 2, 4, 5 or 6 material compartment hoppers
- Wide choice of add on feeders for specialist dosing applications
- Removable hoppers for quick color changes
- Up to 8 materials



8

## 1200 Series

### Throughput Capacity

Up to: 5400 lb/hr | 2450 kg/hr

- 2 models available
- For large injection & blow molders, extrusion lines and central blending
- Ideal specialist dosing designs for a combination of pellets, powders, flakes liquids or other challenging materials that need precise control
- Wide choice of add on feeders for specialist dosing applications
- Up to 12 materials



9

## 2400 Series

### Throughput Capacity

Up to: 7000 lb/hr | 3000 kg/hr

- Base unit with multiple hopper / feeder configurations and choices
- For large injection & blow molders, extrusion lines, central blending
- Ideal specialist dosing designs for low density / poor flow materials like regrind / flake / wood flour
- Wide choice of add on feeders for specialist dosing applications
- Up to 12 materials



10

## 3000 Series

### Throughput Capacity

Up to: 11000 lb/hr | 5000 kg/hr

- Base unit with multiple hopper / feeder configurations and choices
- For large injection & blow molders, extrusion lines, central blending
- Ideal specialist dosing designs for low density / poor flow materials like regrind / flake / wood flour
- Wide choice of add on feeders for specialist dosing applications
- Up to 12 materials

i

## Throughput Ranges

Determined by number of materials in a blend, format, flow and density of raw materials, and process installation.



A blender for every process and application - more models than any other producer with off the shelf solutions built on experience.



Please visit [www.maguire.com](http://www.maguire.com) to download our product data sheets.

**BLENDING APPLICATIONS UP TO: 450 lb/hr | 200 kg/hr**

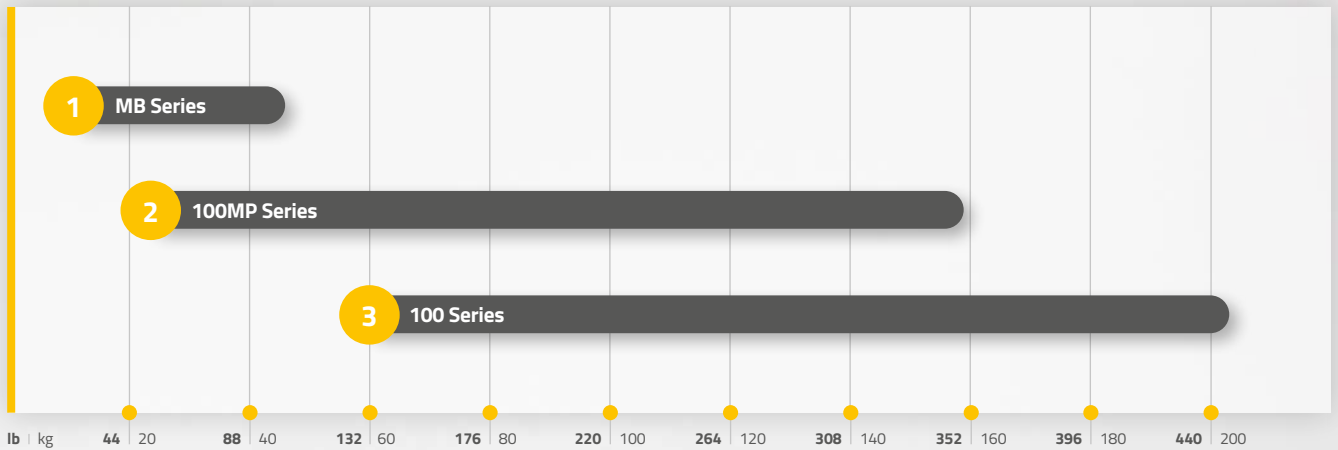

**BLENDING APPLICATIONS UP TO: 4500 lb/hr | 2041 kg/hr**

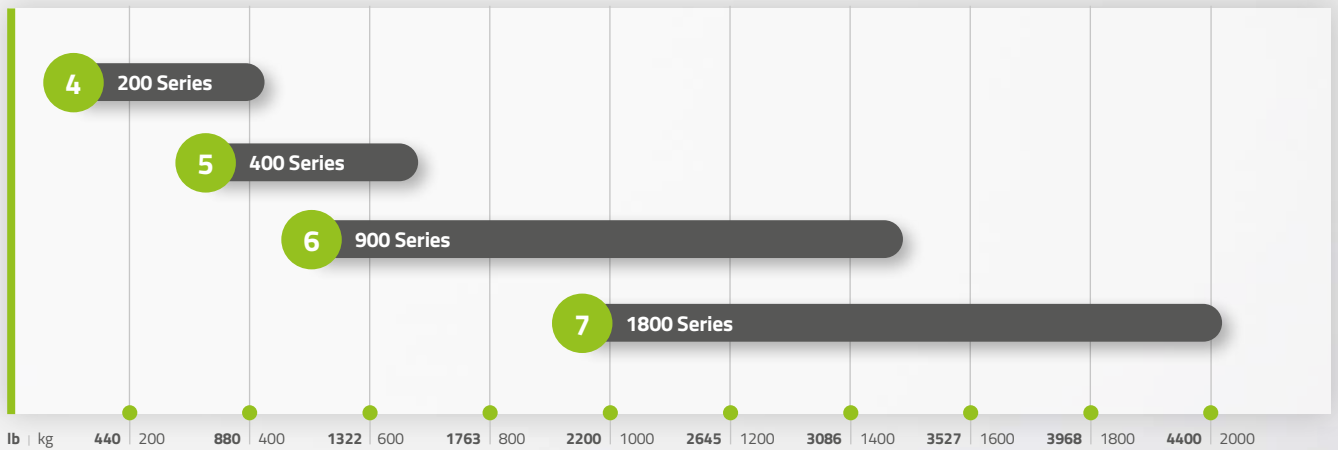

**BLENDING APPLICATIONS UP TO: 11000 lb/hr | 5000 kg/hr**

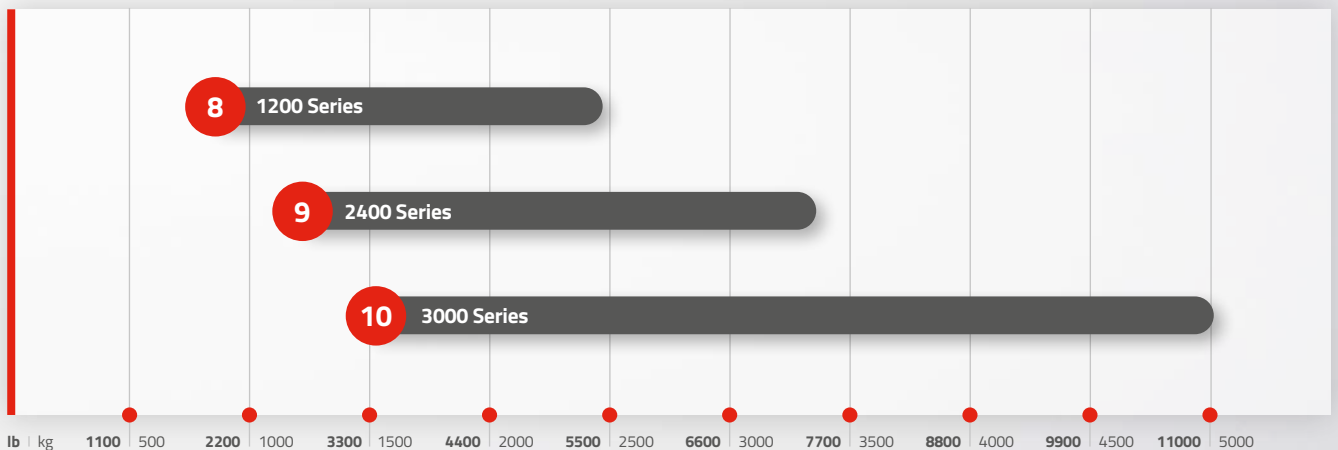

# WSB Blender - For all Molding & Extrusion Applications

**Simple Operation – Load, Set, Blend.** Load material hoppers with regrind, natural, color and additive. Set the recipe percentage for each material. Run the blender and the system will automatically weigh out each material into a batch, and then blend batch to batch direct to your process.



## 1 High Precision Accuracy

- Precision dosing accuracy
- ± 0.1% on a 1% setting
- All materials controlled by same precision
- Precision dynamically adjusts as densities / flow rates change

## 2 Intuitive Control Software

- System monitors accuracy of total recipe
- Adjusts dosing automatically
- Automatic error correction control

## 3 Regrind Control

- Software and hardware controls regrind effectively
- System manages flow rates and regrind availability
- Options for maximizing regrind consumption & minimizing color if color already present in regrind

## 4 Color & Additive Control

- Precision dosing devices for accurate, repeatable control
- Integrated software to optimize dosing accuracy in relation to whole blend
- Savings of 30% or more compared to manual / volumetric dosing



## 5 Vibration Management

- System is proven to manage accuracy in vibration environments
- Unique controls and features to enhance even extreme environments
- Dosing and mixing is robust even in high vibration environments

## 6 Integrated Conveying Control

- Touchscreen controller allows easy control of conveying to and from blender
- Simple user-friendly graphical control
- Manage conveying, dosing and blending all in one control

## 7 Standard Solutions of every Process

- Throat mounting for optimum mixes in molding applications
- Range of online and offline solutions for all extrusion applications
- Central blending applications

## 8 Complete Materials Data

- Blender measures every gram of every material
- Complete usage data for QC / process control / costing / ISO
- Full user and alarm history

### 4088 Controller

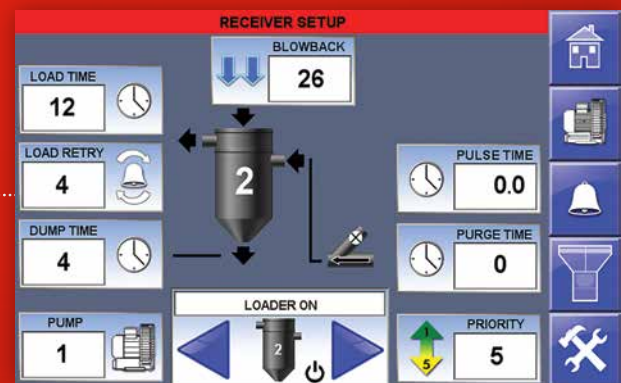



# WXB Blender - For Extrusion Applications

With Integrated Loss-In-Weight Control

The WXB Series of blenders offer all the functionality and capabilities of the WSB, plus add unique features and benefits for extrusion applications:



## +9 Integrated Blending & Extrusion Control

- Precise dosing of all raw materials into a batch
- Mix chamber integrated as a loss-in-weight hopper
- Loss-in-weight updates process consumption every second

## +10 Extrusion Control – Saving up to 10% of Materials Cost

- Switching from manual regulation to automatic extrusion control allows significant savings
- Savings by reduced start-up material waste & changeover scrap
- Immediate control by responding to actual material consumption versus target required
- Rapid return on investment

## +11 Faster Material & Job Changes

- WXB blender allows the integrated blender and loss-in-weight control to mount direct to process
- Less materials mixed and in process
- Quicker direct access and quick material changes

## +12 Solutions for many Extrusion Processes

WXB Gravimetric Blending can bring major benefits to:

- Blown film and cast film processes
- Sheet extrusion
- Pipe, profile & tube extrusion
- Cable & wire extrusion

## +13 Maguire+Syncro Control Flexibility

- Detailed control of materials settings, layer ratio control & extrusion control
- Control allows effective control for mono and co-ex processes, managed from 1 HMI
- Modular upgrades available for air rings, IBC, gauging and wide range of control options for optimizing different extrusion processes

## +14 Integrated Loss-in-Weight

- The WXB mix chamber is also a loss-in-weight hopper
- The cantilever design offers consistent lb/hr or kg/hr data
- The design operates effectively as process ramps up or down, as well as during the mixing process

WXB 460 MODEL



### HMI



# Processes

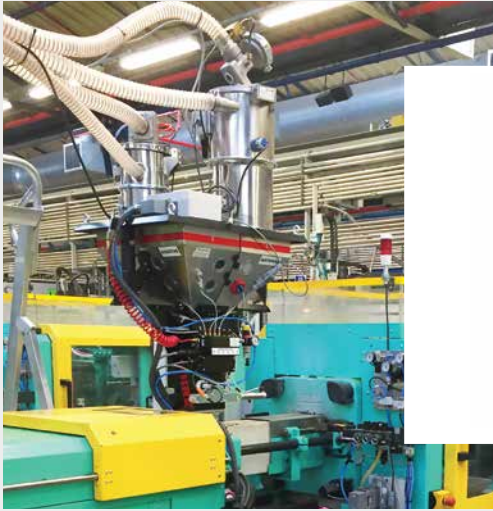

## Injection Molding

### Benefits include:

- Vibration management
- Color and additive control
- Rapid changeover
- Scrap reduction



## Blow Molding

### Benefits include:

- Blend control
- Automatic regrind usage
- Expensive masterbatch control
- Cost reductions
- Process control

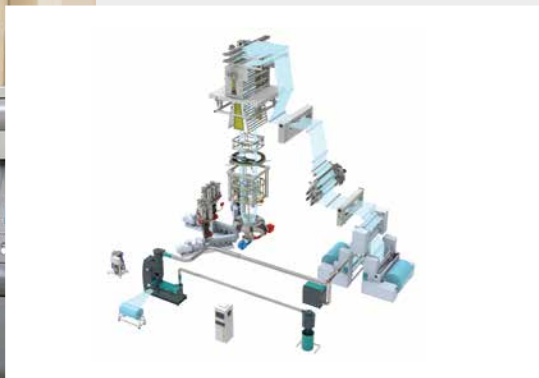

## Film & Cast Extrusion

### Benefits include:

- Quick payback
- Process fluffy scrap accurately
- Continuous material flow
- Material savings





## Sheet Extrusion

**Benefits include:**

- Quick payback
- Process fluffy scrap accurately
- Continuous material flow
- Regrind control
- Material savings



## Pipe & Profile, Wire & Cable Extrusion

**Benefits include:**

- Control the flow of material
- Digital encoder
- Haul off speeds
- Process control

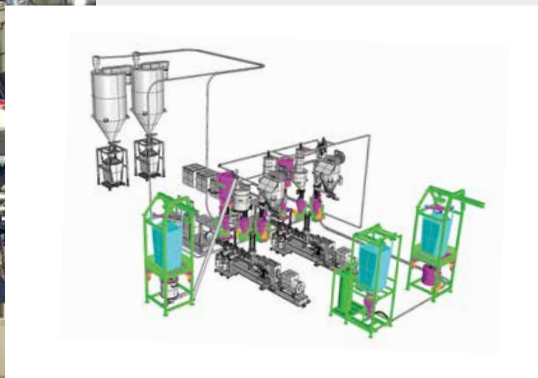

## Compounding

**Benefits include:**

- Quick payback
- Process all materials accurately
- Continuous material flow
- Material savings

# Controls

**Introducing the world's most intuitive next generation blender controller.** The Maguire 4088 controller has an option of a removable touchscreen interface with embedded conveying software to control loading of multiple materials into a blender.

### Benefits of the 4088 FlexBus Lite:

- ✓ Thumbwheel Control Or Regular Touchscreen
- ✓ Integrated Loading Control
- ✓ Greater Data Processing Capability
- ✓ Fully Retrofittable



### 4088 Standard:

- Robust & user-friendly
- Easy settings via digital thumbwheels
- Multilingual display
- Multiple features and functions



### 4088 FlexBus Lite Touchscreen





ALL CONTROLLERS INTERCHANGEABLE

**Maguire controllers are interchangeable and backwards compatible allowing controls to be easily upgraded, and easy to service and support.**

With close to 60,000 units in service in the widest range of applications and processes, the software is full of features as standard. The controls improve dosing and blending control across many everyday requests.

All our controllers are interchangeable and backwards compatible to ensure a simple upgrade to the next version.

### Previous Controller Generations

Standard Controller			Touchscreen Controller	
				
<b>6811 Controller</b> Red Display: 1991 to 2007	<b>1212 Controller</b> Blue Display: 2007 to 2019	<b>4088 Standard Controller</b> Standard Control: 2019 onwards	<b>Touchscreen Controller</b> Touchscreen Gen 1: 2009 to 2017	<b>4088 FlexBus Lite Touchscreen</b> 4088 Touchscreen: 2017 onwards

# Data Options



Since 1989 Maguire has been leading the materials blending & dosing communications by providing open access to materials usage data, alongside process information and control.

Customers have a wide choice of means to integrate data to and from Maguire blenders depending on their individual preferences. The choice includes the following:

## Maguire G2 - Off The Shelf Software

Standard software package to allow a user to:

- Build materials database
- Build recipe database
- Send new recipes to blenders
- Monitor production progress and materials usage
- Monitor blender and materials alarms & operator changes
- Report on materials consumption
- Option to integrate to MySQL databases
- Multilingual support

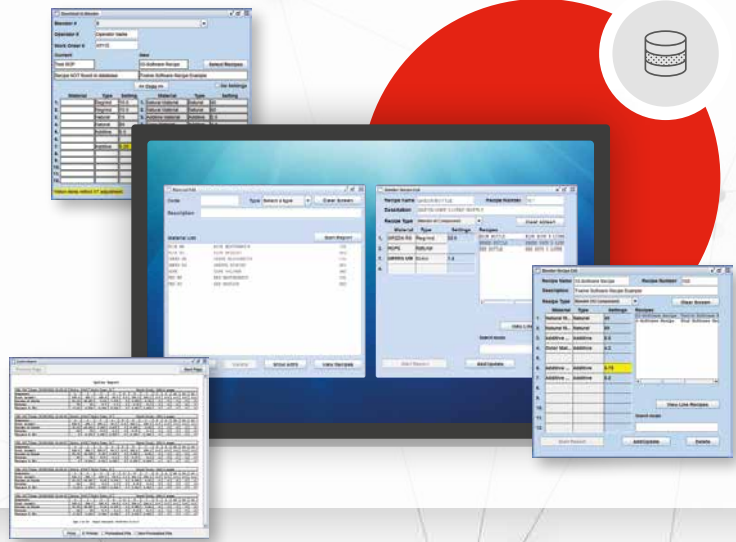

Maguire provides several methods to allow customers to connect their blenders to other third-party systems.

## Fieldbus Protocols

Fieldbus industrial communications, typically for PLC to machine communication are supported by a Fieldbus interface adapter developed for Maguire. Protocols supported include:



## Third-party Database Interface

Connections to leading industry applications via SQL or OPC based links.

Application include: Central PLC Control Panels, SCADA Systems, Plant Wide Control Systems, Accounting Systems managing materials stocks.





# FlexBus Lite

**FlexBus Lite allows a Maguire blender to control up to 10 material receivers and 1 vacuum pump with a full feature conveying control, all built within the blender control.**

FlexBus pump and receiver cards are available to allow a customer to utilize any third-party vacuum pump or receiver and control it from the Maguire blender.



### Fully Retrofittable

The Maguire 4088 touchscreen controller can be easily retrofitted to the vast majority of Maguire blenders installed already, providing the latest generation of controls even if hardware is 15 to 20 years old.



### Full Conveying Control

FlexBus Lite – standard on the 4088 touchscreen. Provides a full feature central conveying control with all the features and functions of central system controls within the blender.



### FlexBus Lite Features

FlexBus includes features typically only found on larger central systems controls including line cleaning, prioritization, backup pump interfaces, and easy management of materials loading times and receiver and pump setup and control.

## Designed For Easy Operation

Our 4088 touchscreen controller uses operator-friendly icons to navigate receiver & pump menus and blender modules.

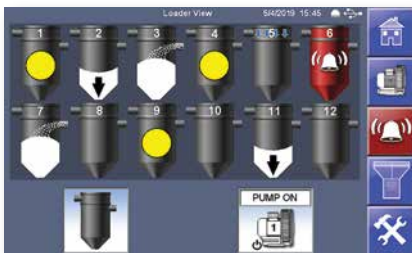

### Home Screen

#### Touchscreen Control Option

Intuitive display shows functions such as:

- Loader Demand
- Loader Discharge
- Loader Filling
- Filter Cleaning
- Alarm

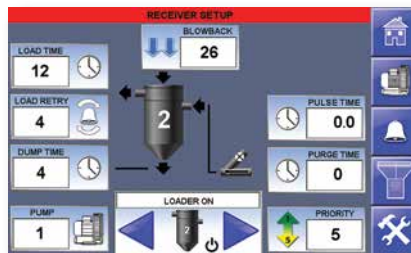

### Receiver Features

#### Full System Functionality

Receiver set up allows you full system functionality control of each receiver - load times, retries, dump time, filter control, line cleaning, and prioritization.

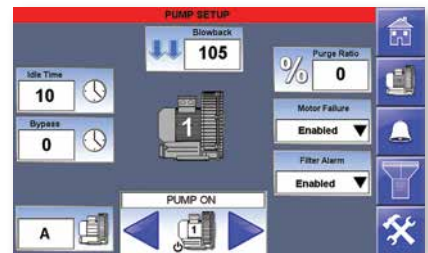

### Pump Features

#### Easy Access To All Features

Pump set up with easy access to all features for complete pump control - back up, easy switch over, controls for bypass, filter cleaning, purge, and alarm monitoring.

# Material Loading

Maguire offers a range of materials conveying options to load raw materials to the blender. These range from single station loaders to complete materials central system solutions. A few examples from the ranges are below:

## ML Series Venturi Loaders



- Compact venturi loader for low throughput loading
- Models to load from 1 to 4 material stations
- Options for alarms and adapters to fit different hopper sizes
- Ideal for masterbatch and additive loading beside the machine

## MLS Conveying Systems

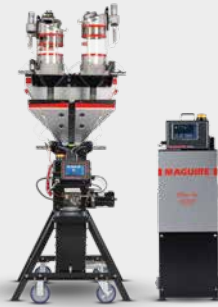

- Localized central conveying for beside the machine
- Flexible and compact – 3 vacuum pump sizes from 1 HP / .75 kW to 11 HP / 7.5 kW
- Range of Clear-Vu receivers for easy visual status on loading
- Compatible with FlexBus & FlexBus Lite systems controls

## GHL Glass-Vu Hybrid Loader



- 5 lb (3.75 L) and 10 lb (7 L) loader capacities
- Single phase motor
- Easy viewing of loading status and easy cleanout / access
- Ideal for single station loading of a main material

## GHR Glass-Vu Hybrid Receivers



- 5 lb (3.75 L), 10 lb (7 L) or 20 lb (14 L) receiver capacities
- Clear-Vu design for easy view of load status / easy cleaning and access
- Air cannon option for high dust filter cleaning
- FlexBus interface or 24 VDC / 110 V interface for third-party systems

## GSL Brushless Vacuum Loader



- GSL-12 650 lb/hr / 300 kg/hr or GSL-19 1000 lb/hr / 450 kg/hr
- Lid body & tilt design for easy access / cleaning
- Heavy duty filter with filter cleaning
- Robust brushless motor for high throughput standalone loading

## FlexBus Receiver Control



- Control interface for FlexBus Lite / FlexBus central systems
- Allows third-party interface via 24 VDC
- Easily convert third-party receiver to run on FlexBus
- Quick & easy to retrofit

## LowPro Conveying Systems



- Ultra-low profile
- Simple easy access
- Range of receiver sizes
- Ideal for low headroom applications and standalone solutions for 3 or 4 materials

















## FlexBus Vacuum Pump Control



- Control interface for FlexBus Lite / FlexBus central systems
- Allows third-party interface via 24 VDC
- Easily convert third-party vacuum pump to run on FlexBus
- Quick & easy to retrofit

# Dosing and Dispense Devices

Dispense devices provide the ability to dose a flexible range of percentages for different material types with maximum accuracy and control.

<p style="writing-mode: vertical-rl; transform: rotate(180deg);"><b>LARGE GRAM TARGET</b></p>	<p><b>3" x 6" Slide Gates (1200 G)</b></p>  <p>Standard dispense device for free-flowing materials.</p>	<p><b>High Volume Pivot Valve</b></p>  <p>Dispense valve for granules for high throughput applications.</p>	<p><b>Corner Valve</b></p>  <p>For poorly flowing regrind or high volume pellets.</p>	<p><b>Wood Floor / Powder Feeder</b></p>  <p>For low bulk density powders, model AWF/64.</p>
<p style="writing-mode: vertical-rl; transform: rotate(180deg);"><b>MEDIUM GRAM TARGET</b></p>	<p><b>2" x 3" Slide Gates (1200 G)</b></p>  <p>Standard dispense device for free-flowing materials.</p>	<p><b>Pivot Valve</b></p>  <p>Vertical valve for removable hoppers.</p>	<p><b>Add-On Pellet Feeder</b></p>  <p>Add on feeder – 3 sizes – for dosing additive &amp; masterbatch granules.</p>	<p><b>Add-On Powder Feeder</b></p>  <p>Add on feeder – 3 sizes – for dosing free flowing additive powders.</p>
<p style="writing-mode: vertical-rl; transform: rotate(180deg);"><b>LOW GRAM TARGET</b></p>	<p><b>Micro-pulse Valve</b></p>  <p>Vertical valve for low dosing (10 g or less).</p>	<p><b>Add-On Pellet Feeder</b></p>  <p>Add on feeder – 3 sizes – for dosing additive &amp; masterbatch granules.</p>	<p><b>Add-On Powder Feeder</b></p>  <p>Add on feeder – 3 sizes – for dosing free-flowing additive powders.</p>	<p><b>Add-On Liquid Color Feeder</b></p>  <p>Liquid color pump integrates to blender to dispense liquid colors and additives.</p>
	<p><b>Hopper Extensions</b></p>  <p>Range of hopper extension sizes for different models to increase storage capacity.</p>	<p><b>Bridge Breakers</b></p>  <p>Range of bridge breakers to help keep regrind / flake flow consistent.</p>	<p><b>Low Lever Hopper Alarm</b></p>  <p>1 to 6 position low level hopper sensors to alert critically low materials in material hoppers.</p>	<p><b>Removable Hopper Receiver Support Bracket</b></p>  <p>Support bracket for two removable hoppers, for easy hopper access and removal.</p>



# Product Configuration: Installation Options

Generally, there are 3 ways a Maguire blender can be installed for the process. Maguire provides a range of accessories to assist, depending on the preference.

## WSB / WXB - Throat Mount

**Installation Benefit** - Machine mount on throat ideal for optimum mix control, minimal cleaning in materials changes, maximize use of space around process machine.

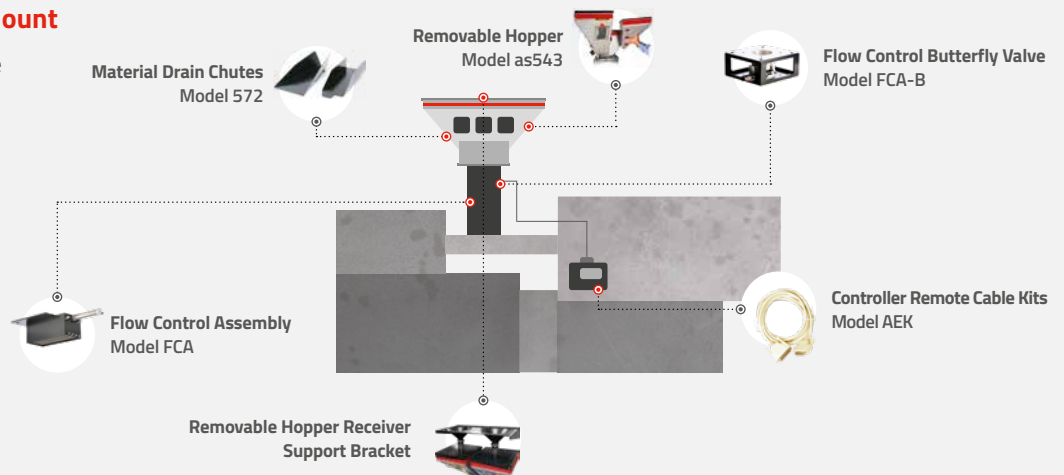

## WSB - Mounted On Floor Stand

**Installation Benefit** - Blenders mounted on floor stand allow for easy access beside the machine for material changes and cleaning.

**Flow Control** - FCA valve between blender and stand ensures material held in mix chamber for good mixing prior to automatic release to materials bin below.

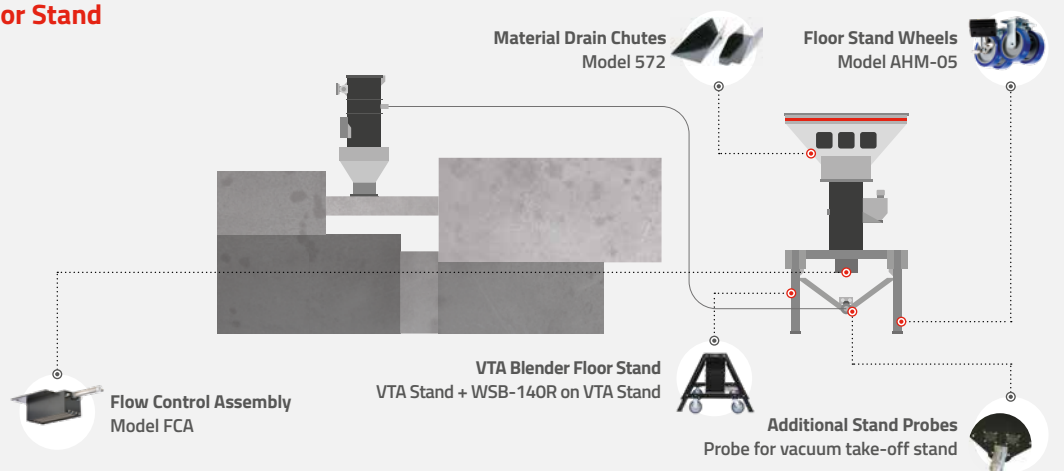

## WSB - Mounted On Mezzanine Floor

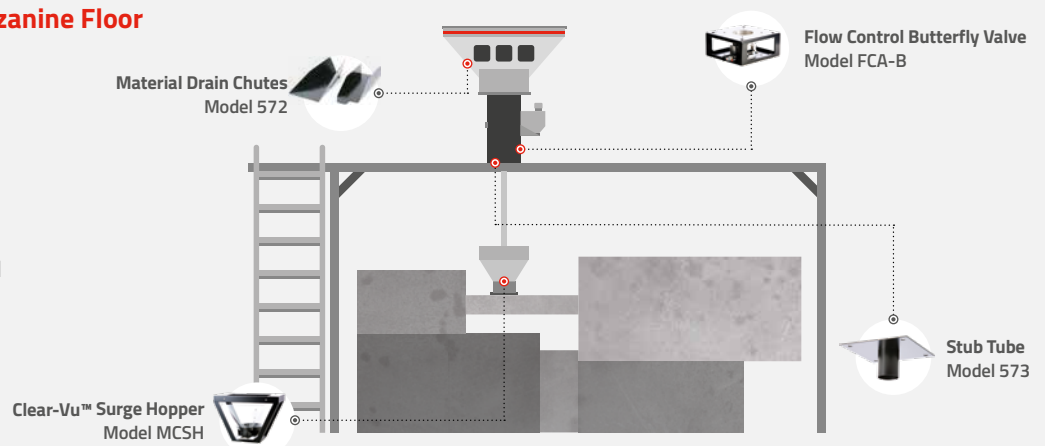

**Installation Benefit** - Blenders mounted on mezzanine floor allows for easy access above the machine for material changes and cleaning.

**Flow Control** - FCA-B butterfly valve between blender and feed to machine ensures material held in mix chamber for good mixing prior to automatic release to process machine.



# Where To Find Us

Our aim is to support our customers locally, with our extensive global network of agents and distributors.

-  Maguire Headquarters
-  Agents & Distributors

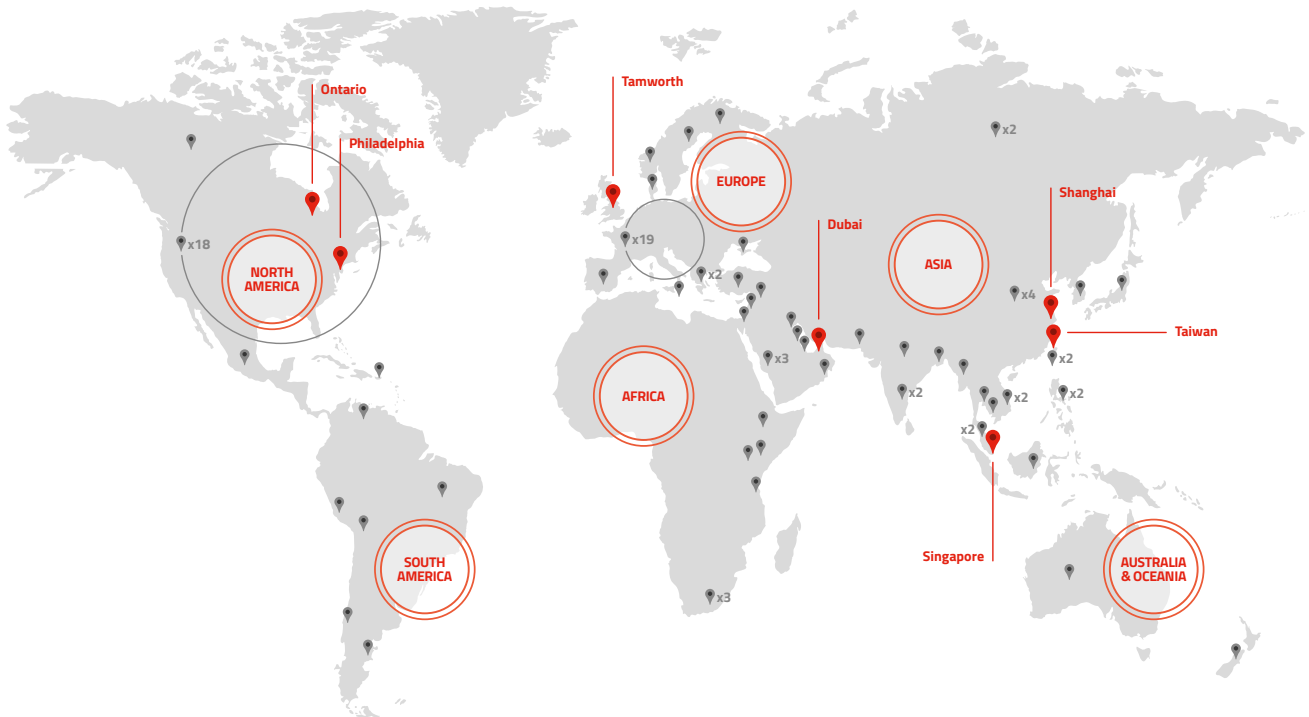

## Contact Our Teams



Tel.: +34 93 652 56 80

[alimatic@alimatic.com](mailto:alimatic@alimatic.com) - [www.alimatic.com](http://www.alimatic.com)

**Maguire USA**  
Aston, PA, USA  
T: +1 610 459 4300  
F: +1 610 459 2700  
E: [info@maguire.com](mailto:info@maguire.com)

**Maguire Canada**  
Ontario, Canada  
T: +1 905 879 1100  
F: +1 905 879 1101  
E: [info@maguirecanada.com](mailto:info@maguirecanada.com)

**Maguire Europe**  
Staffordshire, UK  
T: +44 1827 338 280  
F: +44 1827 338 285  
E: [info@maguire-europe.com](mailto:info@maguire-europe.com)

**Maguire IMEA**  
Dubai, UAE  
T: +971 4 817 0419  
E: [info@maguire-imea.com](mailto:info@maguire-imea.com)

**Maguire Asia**  
Singapore  
T: +65 6848 7117  
F: +65 6542 8577  
E: [magasia@maguire-products.com.sg](mailto:magasia@maguire-products.com.sg)

**Maguire China**  
Shanghai  
T: +86 21 5882 3410  
F: +86 21 5882 3420  
E: [amber@maguirechina.com](mailto:amber@maguirechina.com)

**Maguire Taiwan**  
Taichung City 435  
T: +886 4 2658 1535  
E: [mptw.mgmt@maguire.tw](mailto:mptw.mgmt@maguire.tw)

### Connect With Us:

 [@MaguireProducts](https://twitter.com/MaguireProducts)

 [Maguire-Products](https://www.linkedin.com/company/maguire-products)

 [MaguireProducts](https://www.youtube.com/MaguireProducts)

**Innovations For Raw  
Material Handling For  
Over 40 Years - Blending,  
Drying, Feeding &  
Conveying.**

“

**60K INSTALLED BLENDERS SAVES THE WORLD  
OVER 100 MILLION DOLLARS IN REDUCED  
MATERIAL COST AND 600 MILLION DOLLARS IN  
IMPROVED PRODUCTIVITY IN PLANTS PER YEAR,  
THAT IS ALL PASSED ON TO THE CUSTOMER.**

**STEVE MAGUIRE, FOUNDER AND PRESIDENT  
MAGUIRE PRODUCTS INC.**

”

**[WWW.MAGUIRE.COM](http://WWW.MAGUIRE.COM)**





**MAGUIRE®**  
*Intelligent Simplicity*

