

ULTRA DRYERS

The world's first **ULTRA**
low energy dryers.



PRODUCT GUIDE

ULTRA[®]
..... BY **MAGUIRE**[®]



“

The first ULTRA low energy
dryer for all plastic
raw materials.

”



The First ULTRA Low Energy Dryer

Energy efficiency is the number one criteria for selecting dryers or replacing existing dryers! See below the desiccant high energy components, versus the ULTRA low energy components.

Desiccant High Energy Components	ULTRA ULTRA Low Energy Components
<p>ENERGY INTENSIVE</p> <p>Intensive energy used to HEAT the material.</p>	<p>ENERGY EFFICIENT</p> <p>Minimal energy used to HEAT the material.</p>
<div style="background-color: #333; color: white; border-radius: 50%; width: 60px; height: 60px; display: flex; align-items: center; justify-content: center; margin: 0 auto;"> VS. </div>	
<ol style="list-style-type: none"> <li style="margin-bottom: 15px;">1 Regeneration Process: Desiccant beds become saturated with moisture and need to be regenerated which is energy intensive. <li style="margin-bottom: 15px;">2 Extra Blowers & Heating Unit: Regeneration requires a separate heating unit, and separate blower which is energy intensive. <li style="margin-bottom: 15px;">3 Frequent Maintenance: The desiccant beds require replacement after 18-24 months. Filters need to be maintained weekly. Expensive dew point meters are required to ensure correct dew point & calibration. <li style="margin-bottom: 15px;">4 Large Drying Hopper: Constantly circulating a required level of airflow through large drying hoppers for residence times of 4-6 hours. 	<ol style="list-style-type: none"> <li style="margin-bottom: 15px;">1 Vacuum Drying Process: No regeneration process. No added energy used. <li style="margin-bottom: 15px;">2 Only one smaller blower & heating unit required: For smaller volume and energy efficiency. <li style="margin-bottom: 15px;">3 Low Maintenance: No scheduled maintenance requirements and no consumables. <li style="margin-bottom: 15px;">4 Compact Heating Hopper: Less material in process, less energy used. <p>⚡ ULTRA efficient in every way!</p>

ULTRA also offers significant benefits over desiccant in all of these criteria

Return on Investment	Material Changeover	Time	Cost of Ownership	Maintenance	Scrap Rate
What is the initial purchase cost of the dryer?	How quick can you change material?	How long does it take to dry raw materials?	What is the real cost of the dryer?	How much maintenance & servicing?	Drying control & sufficient dry time?

The First ULTRA Low Energy Dryer

DRYER ENERGY COSTS YOU CAN NOW CONTROL



The difference in energy used to dry material, after it's brought up to temperature is huge:

A Desiccant Dryer Uses:

45 | **100**
Watts/lb/hr | Watts/kg/hr

VS.

Our ULTRA Dryers Use:

4 | **8**
Watts/lb/hr | Watts/kg/hr

Switching from Desiccant to ULTRA

Saves You:

41 | **92**
Watts/lb/hr | Watts/kg/hr



Key Benefit: Energy Savings

The ULTRA low energy dryer is the most efficient dryer available in the market today.

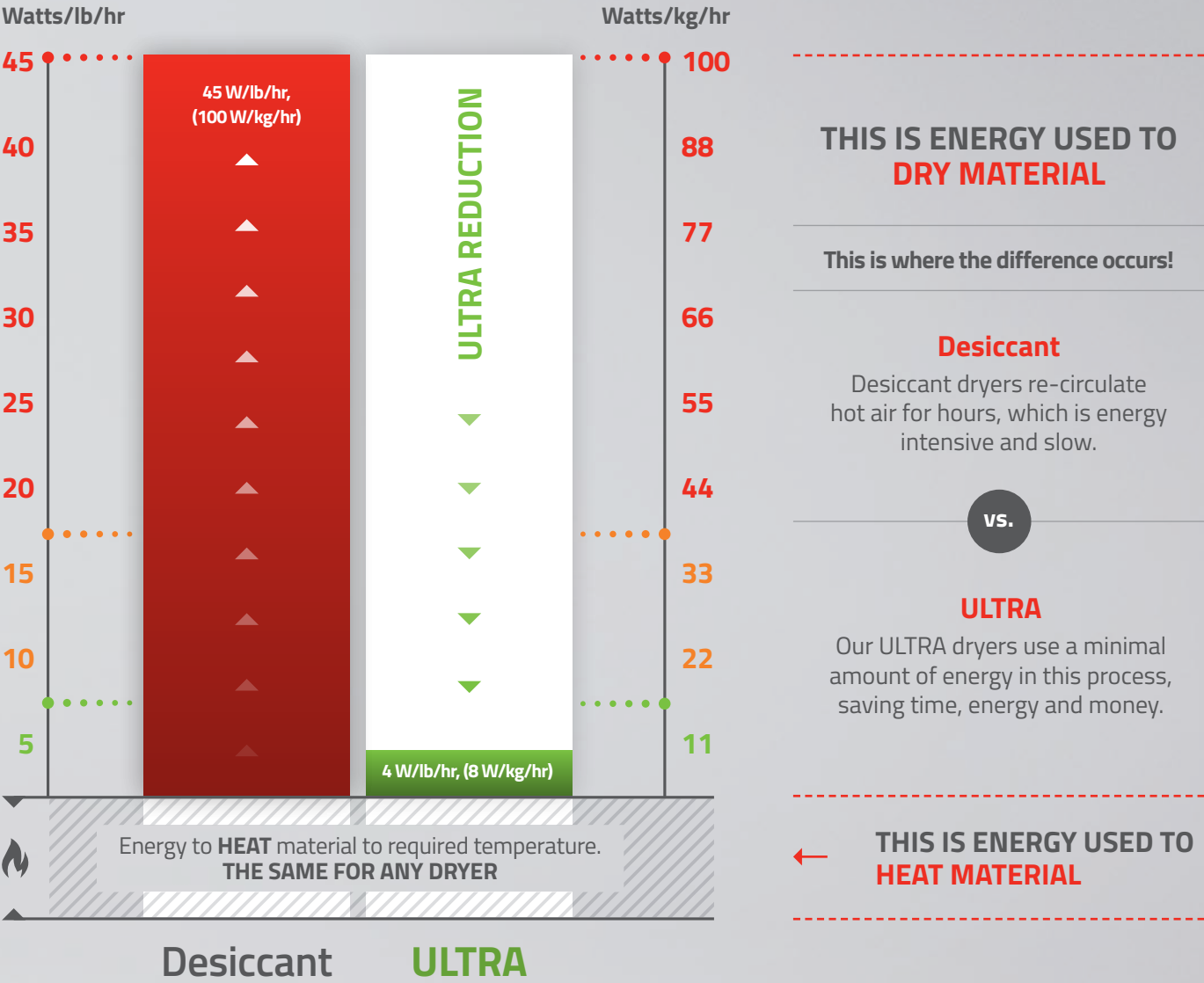

THIS IS ENERGY USED TO DRY MATERIAL

This is where the difference occurs!

Desiccant

Desiccant dryers re-circulate hot air for hours, which is energy intensive and slow.

vs.

ULTRA

Our ULTRA dryers use a minimal amount of energy in this process, saving time, energy and money.

THIS IS ENERGY USED TO HEAT MATERIAL

\$7,128* **\$634***

ANNUAL COST TO DRY MATERIAL*

Savings Year on Year

With a kW difference of 41 Watts/lb/hr, 92 Watts/kg/hr using an ULTRA dryer, you can save **\$6,494** annually doing the exact same job.
Savings year on year:

After 5 Year Period	\$32,470
After 10 Year Period	\$64,940
After 15 Year Period	\$97,410

*Based on 220 pounds per hour, 6000 hours per year, kW cost at national average of \$0.12 per kW, measured at 80% of rated max throughput. This chart shows the EXCESS ENERGY required to DRY the material.

ULTRA Efficient Drying Process

What makes the ULTRA low energy dryer the most efficient drying system on the market?

ULTRA Low Maintenance

- Touchscreen identifies problems by highlighting area in red service box.
- For example: Low air pressure
- System will not RUN if the process requirements are not met:

- 1 No vacuum / no heat
- 2 System logs alarms

✓ **ULTIMATE PROCESS EFFICIENCY**

By design the ULTRA low energy dryer has no scheduled maintenance requirements:

- No desiccant beds to replace
- No process filters to clean and change
- No regeneration cycles
- No cooling requirements
- No chilled water connections

ULTRA Energy Saver

Temperature Sense: Temperature is controlled efficiently with energy saver modes built in as standard.

✓ **ENERGY EFFICIENT DRYING**

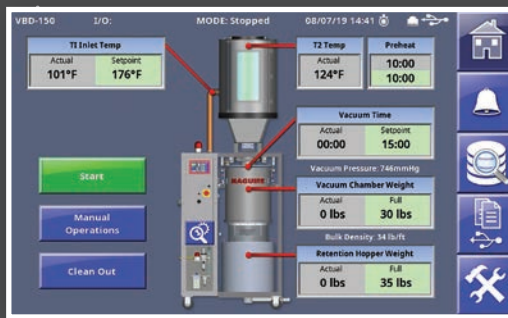

ULTRA Smart Drying

- Onboard Flexbus Lite offers a full feature control to load/offload material from the ULTRA dryer
- Smart feeding of material to process
- Load cells monitor process demand by live lb/hr (kg/hr) consumption
- Automatic adjustment of amount of material under vacuum and in retention hopper feeding the process
- ULTRA signals when to release the next fresh batch
- Retention Insulation: The retention hopper is heavily insulated and enclosed to minimize heat loss and moisture reabsorption

✓ **ULTIMATE PROCESS EFFICIENCY**

ULTRA Green

ULTRA dryers provide further savings from reduced CO₂e - Global Warming Potential (GWP). Running 220.2 lb/hr (100 kg/hr) provides a saving of 54,120 kW a year

This equates to saving:

38.6 tons CO₂e/year

*US Government source
<https://www.epa.gov/energy/greenhouse-gas-equivalencies-calculator>





1

ULTRA Heating Hopper

Less raw material in process due to a compact heating hopper.

✓ INCREASED EFFICIENCY

ULTRA avoids heating material that is not required for the process.

✓ LESS ENERGY USAGE

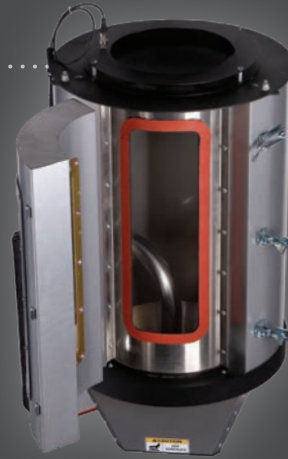

3

ULTRA Load Cells

- Use of load cells in the vacuum chamber and retention hopper allow the drying rate to match the process rate.
- As lb/kg demands go up or down, the ULTRA matches the process requirements accordingly.

✓ COMPLETE PROCESS DATA

✓ EFFICIENT PRODUCTION

5

ULTRA Quick Drying

ULTRA dryers use vacuum as the main method to dry versus air dew point. Drying by vacuum drops the boiling temperature of water to 133°F / 56°C. This creates a temperature and pressure differential that means moisture is rapidly released from the material.

- ✓ Typically, 1/6th of the drying time of conventional desiccant dryers.
- ✓ This dramatically reduces the energy required to DRY material.

✓ MORE PRODUCTION TIME

✓ FASTER MATERIAL CHANGES

✓ MORE MACHINE UPTIME

Example:

Using the ULTRA, Polycarbonate can be dried from cold start-up in **30-40 minutes** compared to **3 hours** in a desiccant dryer.

Dryer Range: Wide Range of Models Available

Maguire offers 4x ULTRA models and 3x LPD models to cater to small and large lb/hr (kg/hr) throughputs.

ULTRA RANGE



LPD RANGE

The LPD 30 as the standard solution for small lb/hr and kg/hr technical drying requirements.



Throughput Ranges - the ULTRA dryers drying output are determined by the combination of the preheat time and vacuum drying time. Throughputs illustrate typical averages but please refer to expected drying times for specific materials for more accurate information.



Please visit www.maguire.com to download our product data sheets.

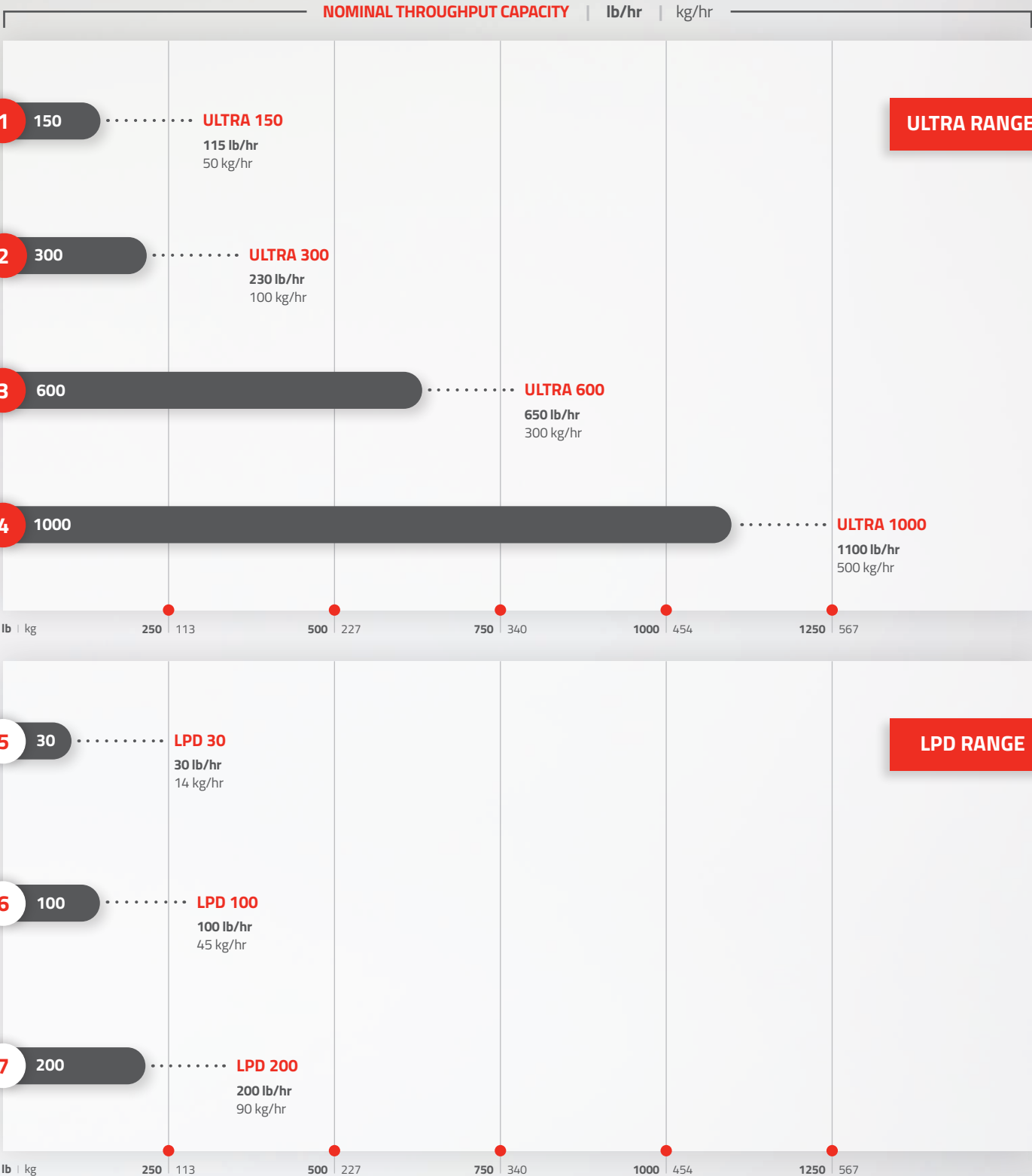

ULTRA Smart Controls and Features

The addition of the touchscreen has allowed us to show the drying process graphically and simply.

ULTRA Smart Controls



Simple Export Function & Program Updates

- Constant development of software features and functions
- Automatic program updates
- USB port provided
- Program updates via flash memory using a standard USB memory device



Monitoring of Numerous Alarm Conditions

- Maintain consistent vacuum level, temperature & cycle time
- Problem indication on display and via alarm light & horn



Easy Retrofittable

- Easy removal for service or replacement
- Multilingual support



Access to all Production Parameters in one Screen

- lb/kg in vacuum chamber
- lb/kg in retention hopper
- Live current lb/h (kg/h)
- Total lb/kg used in a process or batch



FlexBus Lite Materials Conveying Control

- Control up to 10 material receivers & 1 vacuum pump
- Full features like line cleaning
- Visual and easy to see conveying status to and from ULTRA dryer
- Works with Maguire & third-party loading equipment

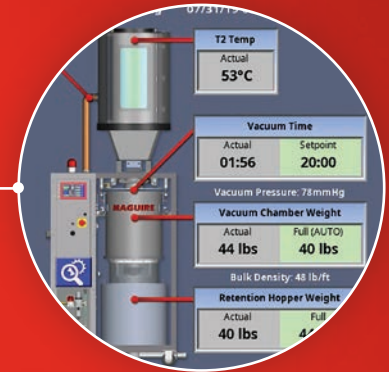

Our touchscreen automates many routine functions

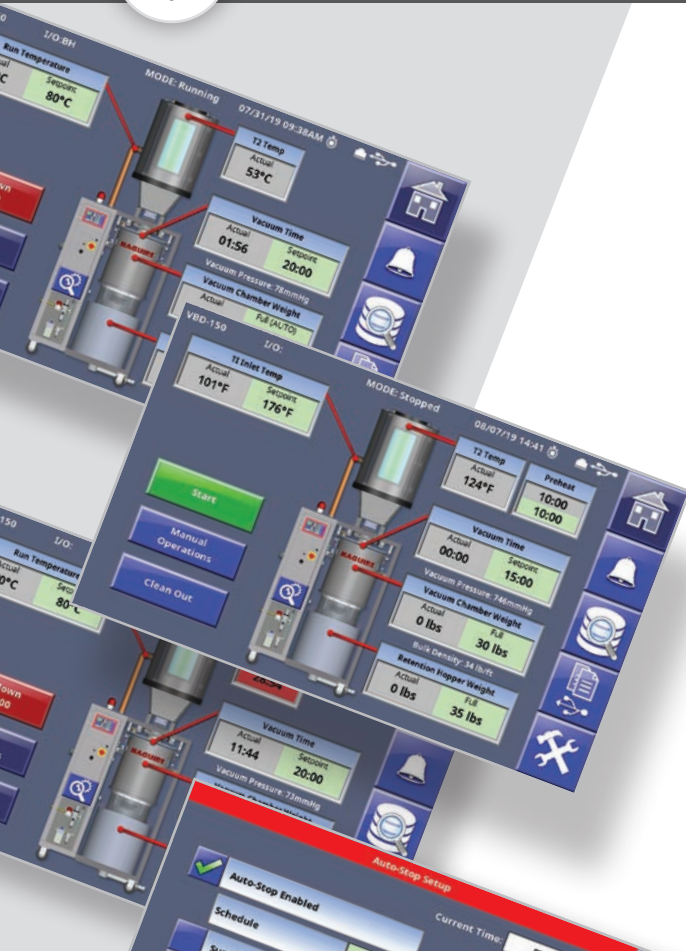

ULTRA Unique Features



Auto Start

Scheduled and automatic start-ups controlled by time.



Auto Stop

Use of load cell data to automatically finish a drying run of a batch of material.
Result: Leaving all hoppers empty & ready for faster / more efficient material changes, simpler production stop.



Dynamic Drying

Use of load cell data to automatically adjust drying rate to process rate.



Energy Saver Mode

Energy saver mode is a standard feature for ULTRA. The heater and blower are automatically regulated to ensure that only the required amount of heat and air flow are used to bring material up to temperature.

Controller Variations



ULTRA Standard Controller



ULTRA Touchscreen Controller

ULTRA Options

Maguire offers a range of options for the ULTRA dryer to meet production and installation requirements.

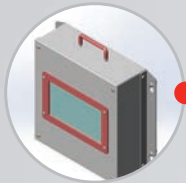

Remote HMI Option

- For remote locations
- Standard cable length '50
- Available for touchscreen only

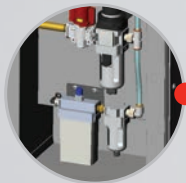

Membrane Dry Air Purge Option

- Provides a supply of -20°C / -68°F dew point air to purge vacuum chamber and blanket the retention hopper
- Prevents moisture re-absorption
- Recommended for highly hygroscopic materials

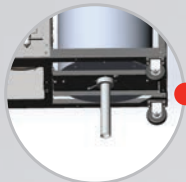

Gravity Feed Option

- Standard later VTA replaced with downward-facing drop tube
- Used for mezzanine / elevated installations

* Requires FCA

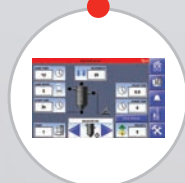

FlexBus Lite Materials Conveying Control

- Materials conveying to dryer & machine or small group of machines made easy
- Integrated full feature conveying control for up to 10 material receivers & 1 vacuum pump
- Visual and easy to see conveying status to and from ULTRA dryer
- Works with Maguire & third-party loading equipment

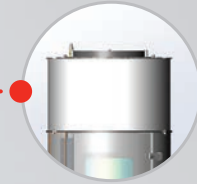

Heating Hopper Extension Option

- Higher throughput capacity of additional 1 cu.ft / 30 L
- Allows for increased heat residence time
- Suitable when drying difficult materials
- Typical materials: PA, PET

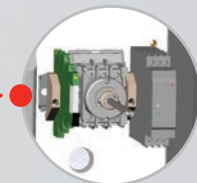

3-Phase Monitoring Option

- Prevents running of dryer if 3-phase rotation is backwards
- Prevents running in case of phase drop out
- Protects blower motor from damage
- Recommended for highly mobile units

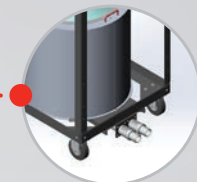

Multi-Point Convey Option

- Lateral convey to more than one receiver



Material Savings Focus

Costs So Low, It's Almost Free!

ULTRA dryers use energy to dry all type of resin at a drastically lower rate than a comparable new desiccant dryer. Savings with the ULTRA dryer are even greater in comparison with a low-efficiency old dryer.

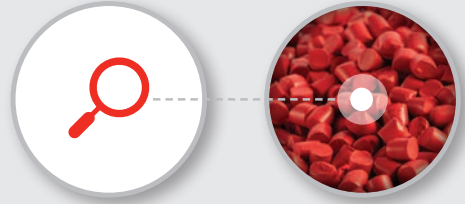

Desiccant vs. **ULTRA**

Material Example	Drying System	Energy to DRY		Energy Cost to DRY*
		Watts/lb/hr	Watts/kg/hr	
ABS At 180°F / 80°C	Desiccant	45	100	\$7,128.00
	ULTRA	4	8	\$634.00
PC At 250°F / 120°C	Desiccant	59	130	\$9,345.00
	ULTRA	5	11	\$792.00
PET At 350°F / 180°C	Desiccant	86	190	\$13,622.00
	ULTRA	7	15	\$1,108.00

Save thousands every year with **ULTRA drying!**

Maguire reserve the right to change and update any information.

How does Desiccant compare to **ULTRA**?

Savings

The savings provided by the ULTRA translate to fast return on investment, without considering other benefits of faster drying, heating & start-up times, significantly lower maintenance, and intelligent operation.



 10 Year ULTRA Drying Saving**	 Heating Time Savings	 Overall Drying Time Savings	 Material in Process Savings
<p>×</p>	<p>180 Mins</p>	<p>Drying Time: 180 Mins Start-up Time: 180 Mins</p>	<p>760 lb 360 kg</p>
<p>▶ \$64,940.00 ◀</p>	<p>15-30 Mins</p>	<p>Drying Time: 20 Mins Start-up Time: 55 Mins</p>	<p>233 lb 105 kg</p>
<p>×</p>	<p>180 Mins</p>	<p>Drying Time: 180 Mins Start-up Time: 180 Mins</p>	<p>750 lb 350 kg</p>
<p>▶ \$85,530.00 ◀</p>	<p>15-30 Mins</p>	<p>Drying Time: 20 Mins Start-up Time: 55 Mins</p>	<p>270 lb 125 kg</p>
<p>×</p>	<p>300 Mins</p>	<p>Drying Time: 300 Mins Start-up Time: 300 Mins</p>	<p>1,100 lb 500 kg</p>
<p>▶ \$125,140.00 ◀</p>	<p>40-60 Mins</p>	<p>Drying Time: 30 Mins Start-up Time: 70 Mins</p>	<p>250 lb 115 kg</p>
<p>ULTRA RETURN ON INVESTMENT</p>	<p><small>*DRY - This is the net energy used in the drying process to DRY the raw material. HEATING a lb or kg, energy usage is the same for ALL types of drying system and therefore excluded from these examples.</small></p> <p><small>**Typical energy costs & savings calculated on lb and kg data. Example based on 220 lb/hr or 100 kg/hr, based on 6000 production hours per year, at an energy kW cost of \$0.12.</small></p>		

ULTRA Dryer Case Study

ULTRA dryers increased drying efficiency at Greiner Packaging, Austria.

Greiner Packaging, a major manufacturer of packaging for food and non-food applications pursues a clear sustainability strategy.

From recyclable products with a high recycle percentage through to an energy efficient production process with reduced CO₂ emissions.

For their raw material drying process in injection stretch blow molding, the company has tested the ULTRA low energy dryer as a replacement for conventional desiccant dryers.



Main Benefit: Energy Savings

Side by side energy trials at Greiner's production facilities have shown a clear reduction in energy consumption compared to conventional desiccant dryers.

ENERGY TO DRY

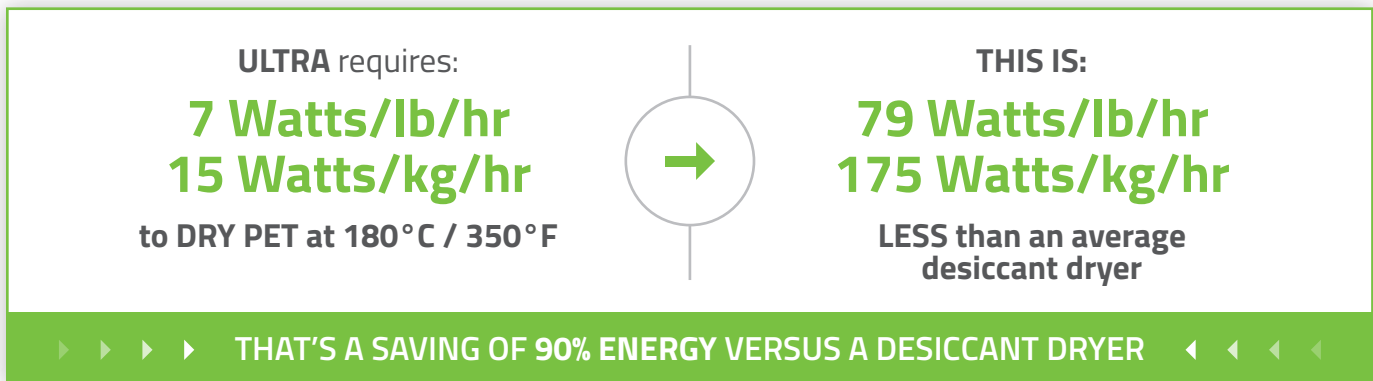

Additional Benefit: Reduced Drying Time

Drying time has been drastically reduced after switching from conventional desiccant dryers to Maguire ULTRA dryers!

<p>Quick material changeovers within 40 mins compared to 3 hours with a desiccant dryer.</p>	<p>⌈ 03 : 00 Hrs ⌋ 00 : 40 Mins</p>
--	---

Additional Benefit: Quick Material Changeovers

Result
More material trials achieved with the UTLRA. 8 material trials per day with the ULTRA, compared to 2 using a desiccant dryer.

8 2

Additional Benefit: Reduced Footprint

By choosing the ULTRA dryer, Greiner have considerably reduced their footprint thanks to ULTRA's vertical, slim and compact design.

ULTRA dryers require **50% less space** than Greiner's conventional dryers where the hopper has to be placed separately.

50%

Material Drying Table

ULTRA versus desiccant drying by material type.

Material	Generic Name	Target Moisture Content	Drying Temp °C	Drying Temp °F	Bulk Density kg/liter	Bulk Density lb/ft³	Desiccant Drying Time Hrs	Vacuum Drying Time Mins
ABS	Acrylonitrile Butadiene Styrene	<0.04	80	176	0,6	37.5	2 to 3	15 - 30
ASA	Acrylonitrile Styrene Acrylate	-	80	176	0,65	40.6	2 to 4	20 - 30
ASA+PC	Acrylonitrile Styrene Acrylate & PolyCarbonate Blend	<0.10	100-110	212 - 230	0,65	40.6	2 to 4	20 - 30
CA*	Cellulose Acetate	<0.15	60-65	140-150	0,5	31.2	2 to 3	N/A
LCP	Liquid Crystal Polymer	<0.02	150-160	302-320	0,6	37.5	4	20 - 30
PA 6	Polyamide 6	<0.04	80	176	0,65	40.6	3 to 5	30 - 40
PA 6.6 / 6.10	Polyamide 6.6 / 6.10	<0.04	80	176	0,65	40.6	3 to 5	30 - 40
PA 11 / 12	Polyamide 11 / 12	<0.04	80	176	0,65	40.6	4 to 6	30 - 40
PAA	Polyarylamide 30GF	<0.10	80	176	0,65	40.6	4	30 - 40
PAEK	Polyaryletherketone	<0.05	150	302	0,65	40.6	4	20 - 30
PAEK-HT	Polyaryletherketone HT	<0.05	180	356	0,65	40.6	4	20 - 30
PAI	Polyamide-imide	<0.05 - 0.01	180	356	0,65	40.6	4	30 - 40
PAR	Polyarylate	<0.02	150	302	0,65	40.6	4	20 - 30
PAS	Polyarylsulfone	<0.05	135	275	0,65	40.6	4 to 5	20 - 30
PBT	Polybutylene Terephthalate	<0.03	120	248	0,7	43.7	2 to 3	20 - 30
PC	PolyCarbonate	<0.02	120	248	0,7	43.7	2 to 3	15 - 30
PC+ABS	PolyCarbonate & Acrylonitrile Butadiene Styrene Blend	<0.04	100-110	212 - 230	0,7	43.7	2 to 3	20 - 30
PC+PBT	PolyCarbonate & Polybutylene Terephthalate Blend	<0.02	105-115	221 - 239	0,7	43.7	2 to 4	20 - 30
PC+PET	PolyCarbonate & Polyethylene Terephthalate Blend	<0.02	105-115	221 - 239	0,75	46.8	2 to 4	20 - 30
PE	Polyethylene	-	90	194	0,6	37.5	1 to 2	20 - 30
PE, Black	Polyethylene, Black Compound	-	90	194	0,6	37.5	1 to 2	15 - 30
PEC	Polyethylene Carbonate	<0.02	130	266	0,7	43.7	4 to 6	20 - 30
PEEK	Polyetheretherketone	<0.05	150	302	0,6	37.5	2 to 3	20 - 30
PEI	Polyetherimide	<0.01	150	302	0,6	37.5	3 to 4	20 - 30
PEK	Polyetherketone	<0.05	160	320	0,6	37.5	4	20 - 30
PESU	Polyarylsulfone	<0.05	120	248	0,7	43.7	3 to 4	20 - 30
PET-a	Polyethylene Terephthalate - Amorphous	<0.02	120	248	0,85	53.1	3	40 - 60
PET-c	Polyethylene Terephthalate - Crystalline	<0.004	170	338	0,85	53.1	6	40 - 60
PETG*	Polyethylene Terephthalate Glycol	<0.05	60	140	0,6	37.5	3 to 4	N/A
PETP	Polyethylene Terephthalate	<0.02	120	248	0,85	53.1	3	40 - 60
PI	Polyimide	-	120	248	0,6	37.5	2 to 3	20 - 30
PMMA	Polymethyl Methacrylate	<0.04	80-100	176-212	0,65	40.6	2 to 3	20 - 30
POM	Polyoxymethylene	<0.10	100	212	0,6	37.5	2 to 3	20 - 30
PP	Polypropylene	-	90	194	0,6	37.5	1 to 2	15 - 30
PP Talc	Polypropylene, Talc Filled 10%	<0.03	100	212	0,7	43.7	3	20 - 30
PP, Black	Polypropylene, Black Compound	<0.03	105	221	0,7	43.7	3 to 4	20 - 30
PPA	Polyphthalamide	<0.15	80	176	0,65	40.6	6	20 - 30
PPE	Polyphenylene Ether	<0.03	110-120	230-248	0,65	40.6	3 to 4	20 - 30
PPE/SB	Polyphenylene Ether & Styrene Butadiene Blend	-	-	-	0,65	40.6	-	20 - 30
PPO	Polyphenylene Oxide	<0.02	110	230	0,5	31.2	2	20 - 30
PPS	Polyphenylene Sulfide	<0.03	150	302	0,6	37.5	3 to 4	20 - 30
PPSU	Polyphenylsulfone	<0.10	150	302	0,65	40.6	2 to 3	20 - 30
PS	Polystyrene	<0.05	80	176	0,5	31.2	1 to 2	20 - 30
PSU	Polysulfone	<0.04	120-135	248-275	0,65	40.6	2 to 3	20 - 30
PUR	Polyurethane	<0.02	90-100	194-212	0,7	43.7	2 to 3	20 - 30
PVC*	Polyvinyl Chloride	<0.20	70	158	0,5	31.2	1	-
SAN	Styrene Acrylonitrile	<0.10	80	176	0,6	37.5	2 to 3	20 - 30
SB	Styrene-butadiene	<0.05	80	176	0,6	37.5	1 to 2	20 - 30
TPE	Thermoplastic Elastomer	<0.03	110	230	0,65	40.6	2 to 3	20 - 30
TPU	Thermoplastic Polyurethane	<0.03	100-110	212 - 230	0,65	40.6	1 to 2	20 - 30

All materials listed are detailed as per general typical requirements regarding typical drying temperature, time and density. Users should always refer to the specific material technical data sheet to confirm specific details for a specific grade of material.

* = Low drying temperatures are not recommended applications for vacuum drying due to proximity of boiling temperature under vacuum being close to 56°C/133°F.

ULTRA Specifications

ULTRA low energy dryers are available for throughputs of 115, 230, 650, and 1100 lb/hr (50, 100, 300, and 500 kg/hr). Like all Maguire products, they are protected by our 5 Year Warranty.

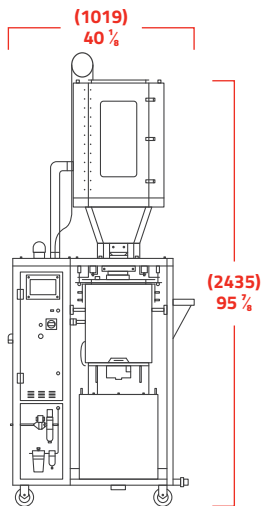
ULTRA[®]
150

Depth = (558) 22

	US	Metric
Practical Heating Hopper Volume	2.5 cu. ft.	70 L
Vacuum Chamber Volume	1 cu. ft.	28 L
Retention Hopper Volume	1.3 cu. ft.	37 L
Max. Temperature	350°F	176°C
Power Requirements	240V, 480V, 575V / 3Ph / 60Hz, 16A, 8A, 7A	400V / 3Ph / 50Hz 10A
Process Heater	10 kW	
Blower	1.1 HP, 105 scfm	0.75 kW, 2973 L/min
Compressed Air Pressure	85 psi	5.86 bar
Compressed Air Usage	5.2 scfm	2.4 N m ³ /h
Product Weight	501 lb	228 kg

For more information, download the ULTRA 150 data sheet at: www.maguire.com

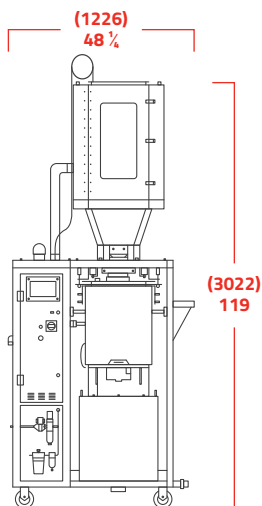
ULTRA[®]
300

Depth = (660) 26

	US	Metric
Practical Heating Hopper Volume	4.25 cu. ft.	120 L
Vacuum Chamber Volume	2 cu. ft.	57 L
Retention Hopper Volume	2.25 cu. ft.	64 L
Max. Temperature	350°F	180°C
Power Requirements	240V, 480V, 575V / 3Ph / 60Hz 52A, 27A, 22A	400V / 3Ph / 50Hz 33A
Process Heater	15 kW	
Blower	3.5HP	2.2kW
Compressed Air Pressure	85 psi	5.86 bar
Compressed Air Usage	3.6 scfm	5.6 N m ³ /hr
Product Weight	918 lb	416 kg

For more information, download the ULTRA 300 data sheet at: www.maguire.com



For LPD specifications, please visit www.maguire.com to download our product data sheets.

**ULTRA[®]
600**

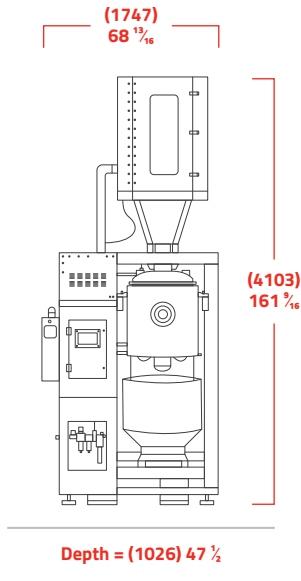

	US	Metric
Practical Heating Hopper Volume	12 cu. ft.	340 L
Vacuum Chamber Volume	5.5 cu. ft.	156 L
Retention Hopper Volume	6.1 cu. ft.	173 L
Max. Temperature	350°F	176°C
Power Requirements	480V, 575V / 3Ph / 60Hz 49A, 22A	400V / 3Ph / 50Hz 54A
Process Heater	20 kW	
Blower	8.5 HP, 400 scfm	5.5 kW, 5380 L/min
Compressed Air Pressure	85 psi	5.86 bar
Compressed Air Usage	11.2 scfm	17.4 N m ³ /hr
Product Weight	1824 lb	827 kg

For more information, download the ULTRA 600 data sheet at: www.maguire.com

**ULTRA[®]
1000**

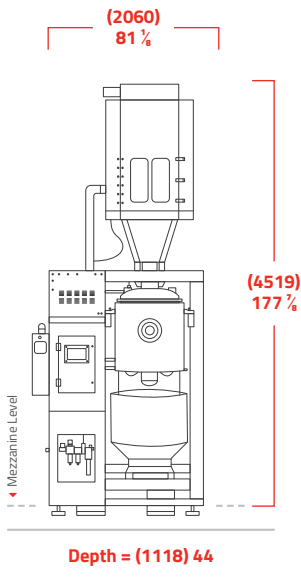



	US	Metric
Practical Heating Hopper Volume	26 cu. ft.	739 L
Vacuum Chamber Volume	10 cu. ft.	283 L
Retention Hopper Volume	11 cu. ft.	311 L
Max. Temperature	350°F	180°C
Power Requirements	480V, 575V / 3Ph / 60Hz 67A, 37A	400V / 3Ph / 50Hz 75A
Process Heater	25 kW	
Blower	10 HP, 600 scfm	7.5 kW, 16990 L/min
Compressed Air Pressure	85 psi	5.86 bar
Compressed Air Usage	18.9 scfm	29.4 N m ³ /hr
Product Weight	2950 lb	1338 kg

For more information, download the ULTRA 1000 data sheet at: www.maguire.com

Where To Find Us

Our aim is to support our customers locally, with our extensive global network of agents and distributors.

-  Maguire Headquarters
-  Agents & Distributors



Contact Our Teams



Tel.: +34 93 652 56 80

alimatic@alimatic.com - www.alimatic.com

Maguire USA
Aston, PA, USA
T: +1 610 459 4300
F: +1 610 459 2700
E: info@maguire.com

Maguire Canada
Ontario, Canada
T: +1 905 879 1100
F: +1 905 879 1101
E: info@maguirecanada.com

Maguire IMEA
Dubai, UAE
T: +971 4 881 6700
E: info@maguire-imea.com



Maguire Europe
Staffordshire, UK
T: +44 1827 338 280
F: +44 1827 338 285
E: info@maguire-europe.com

Maguire China
Shanghai
T: +86 21 5882 3410
F: +86 21 5882 3420
E: amber@maguirechina.com

Maguire Taiwan
Taichung City 435
T: +886 4 2658 1535
E: mptw.mgmt@maguire.tw

Maguire Asia
Singapore
T: +65 6848 7117
F: +65 6542 8577
E: magasia@maguire-products.com.sg

Connect With Us:

-  [@MaguireProducts](https://twitter.com/MaguireProducts)
-  [Maguire-Products](https://www.linkedin.com/company/maguire-products)
-  [MaguireProducts](https://www.youtube.com/MaguireProducts)

**Innovations For Raw
Material Handling For
Over 40 Years -
Blending, Drying,
Feeding & Conveying.**

“

**DRYING COSTS SO LOW,
IT'S ALMOST FREE.**

**STEVE MAGUIRE, FOUNDER AND PRESIDENT
MAGUIRE PRODUCTS INC.**

”

WWW.MAGUIRE.COM



ULTRA[®]
ULTRA LOW ENERGY DRYER

 **alimatic**
www.alimatic.com

MAGUIRE[®]
Intelligent Simplicity